

THE PROPERTY OF THE DRAWING IS ESTABLISHED BY LAW. IT IS FORBIDDEN TO PRODUCE OR SHOW IT TO THIRD PART. WITHOUT A WRITTEN AGREEMENT.

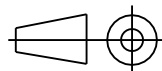
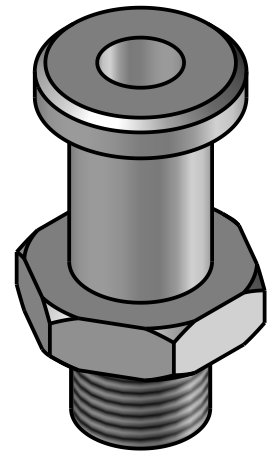
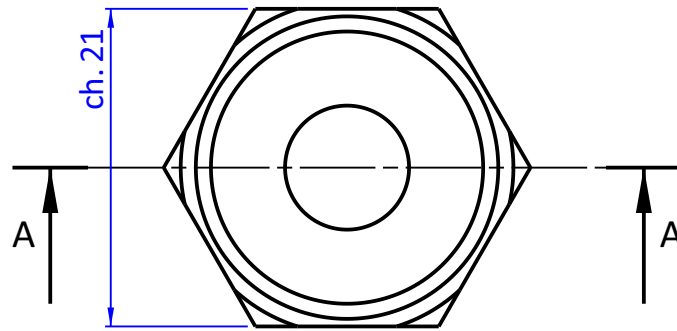
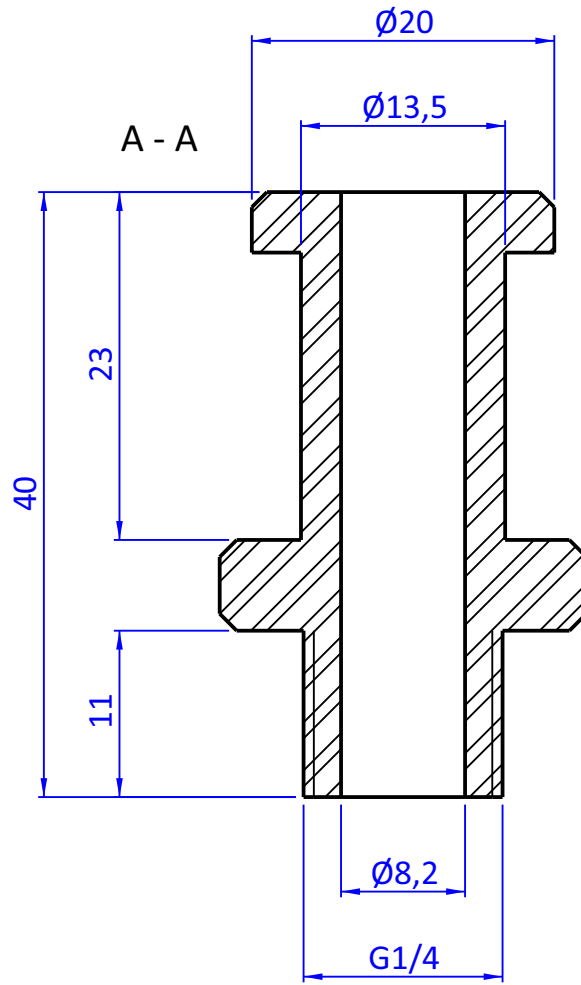

DESIGNED FROM
FPS Automation REVIEW
A

DATE
02/09/2022 WEIGHT
0,015kg

CODE
CA.08.09.024

Format **A4**

UNI 936-76

GENERAL TOLERANCE

UNI - ISO 2768

CLASSE **f**

DESCRIPTION

CA.08.09.024